

TESTNI
KVADRAT
5x5

XS

S

M

L

XL

1A

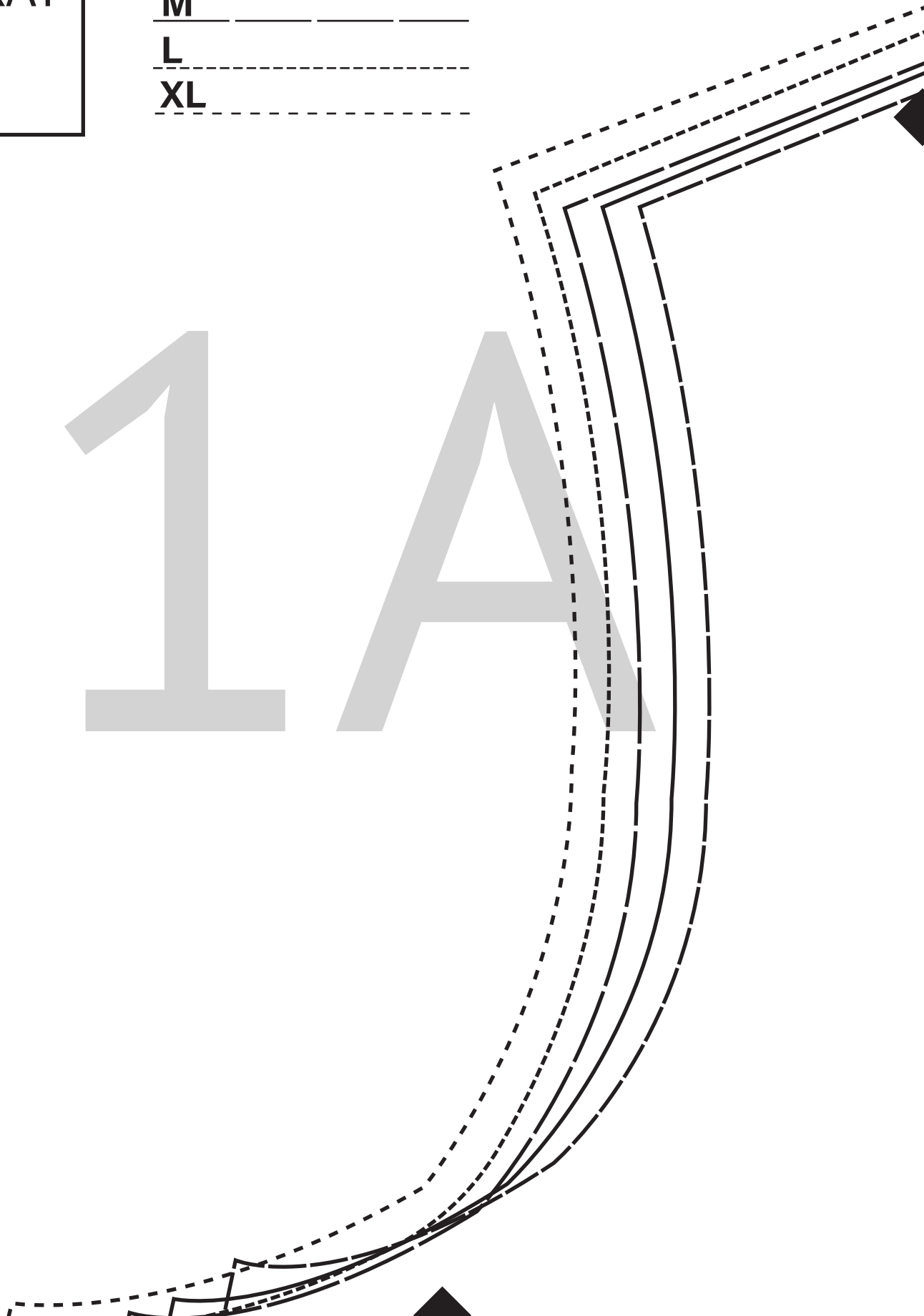

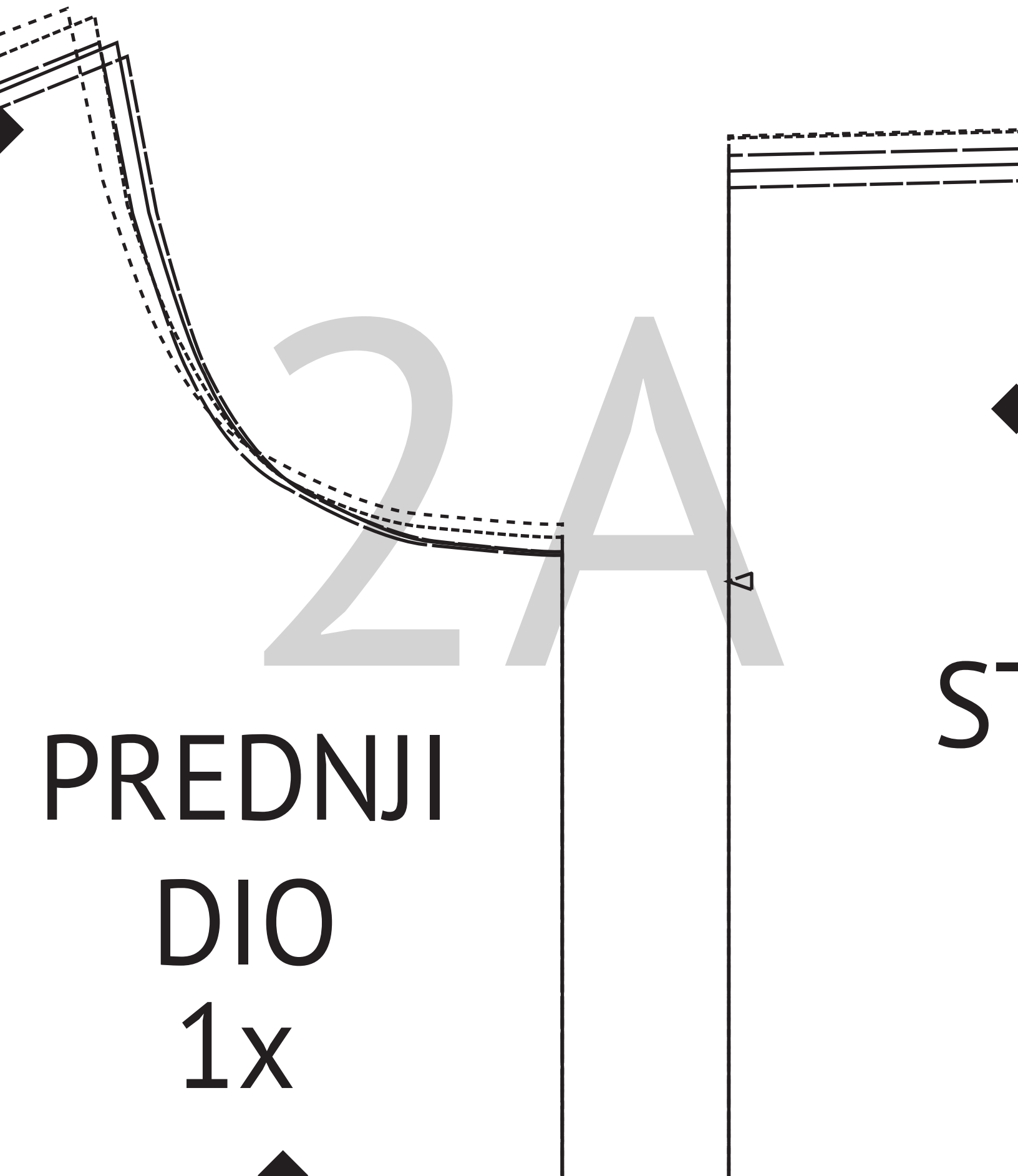

PREDNJI

DIO

1x

S



TRAŽNJI

DIO

2x

4A

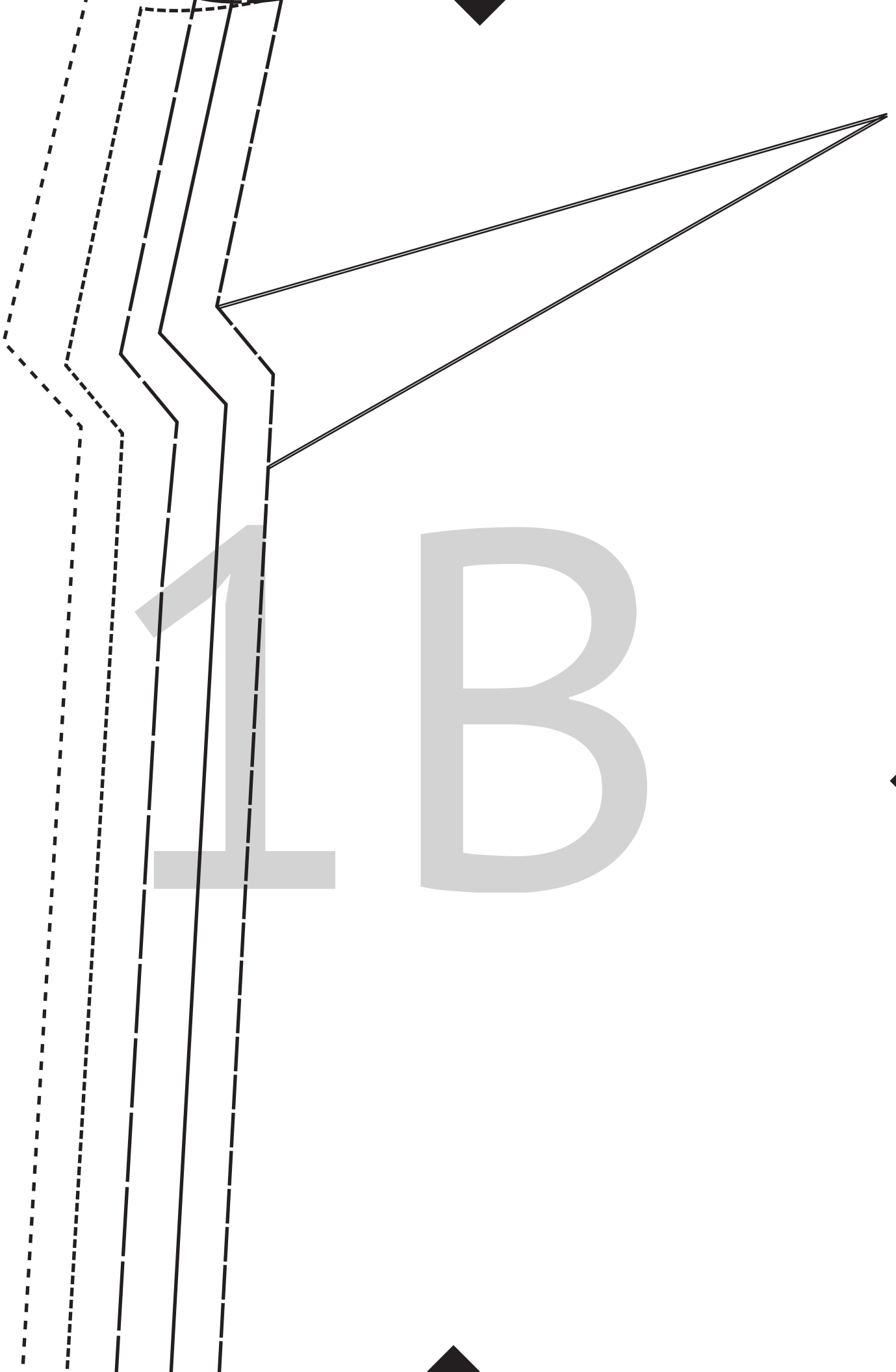

1B

SMJER NITI

PREGIB

2B

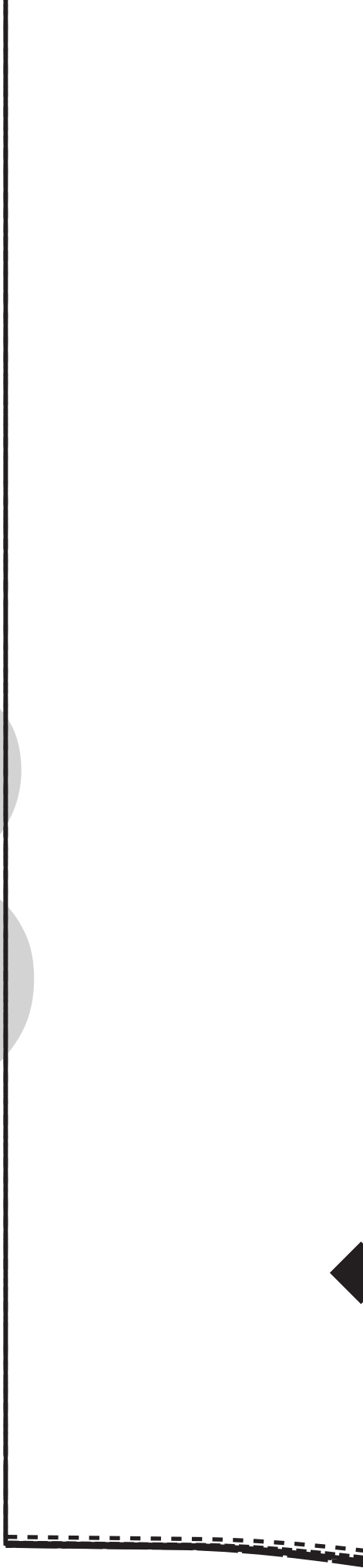
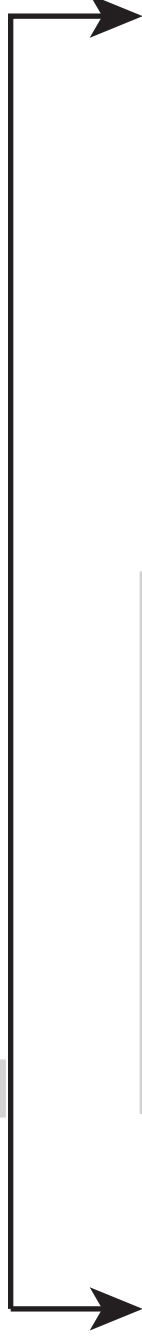

SMJER NITI



3B



4B

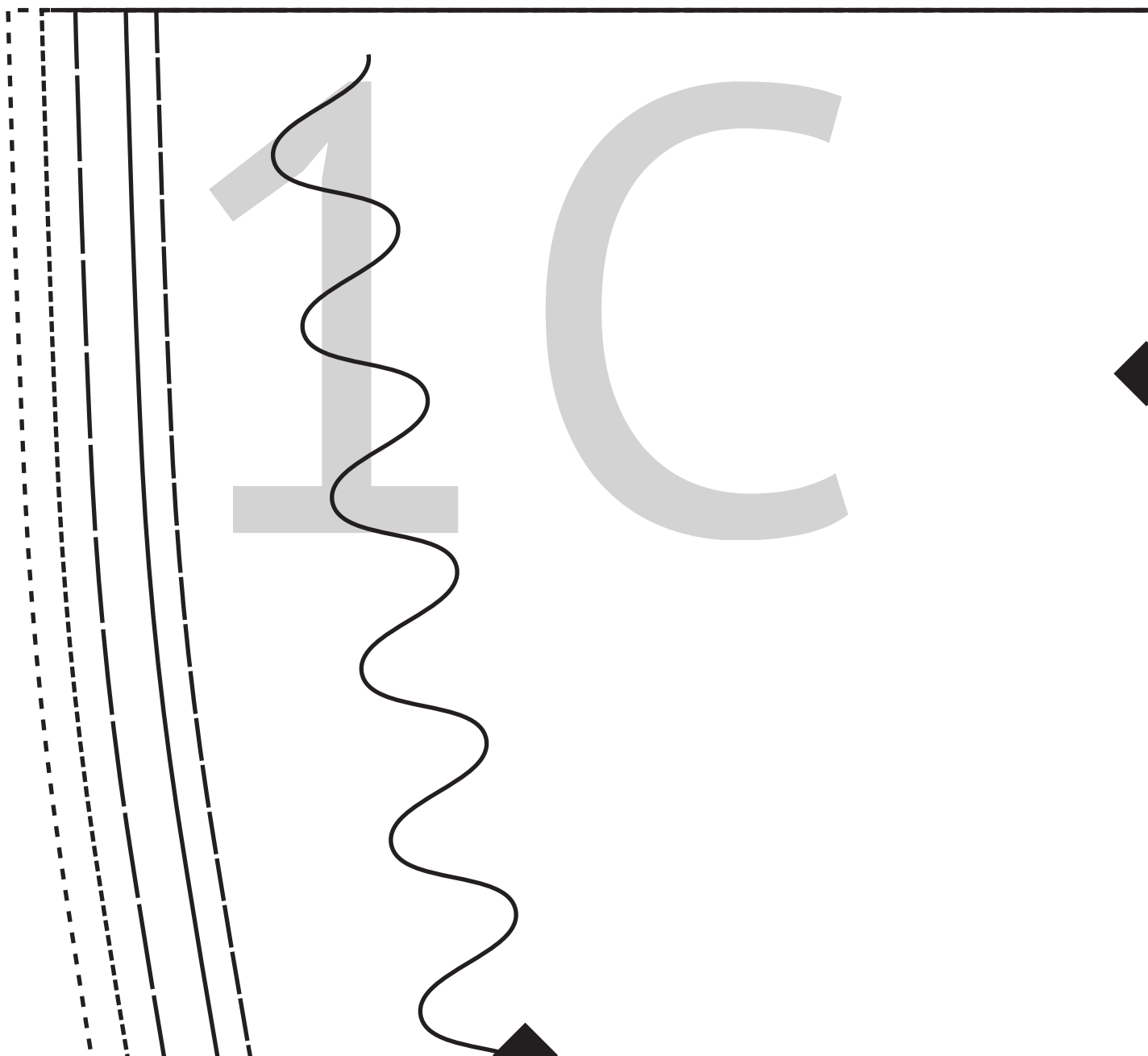
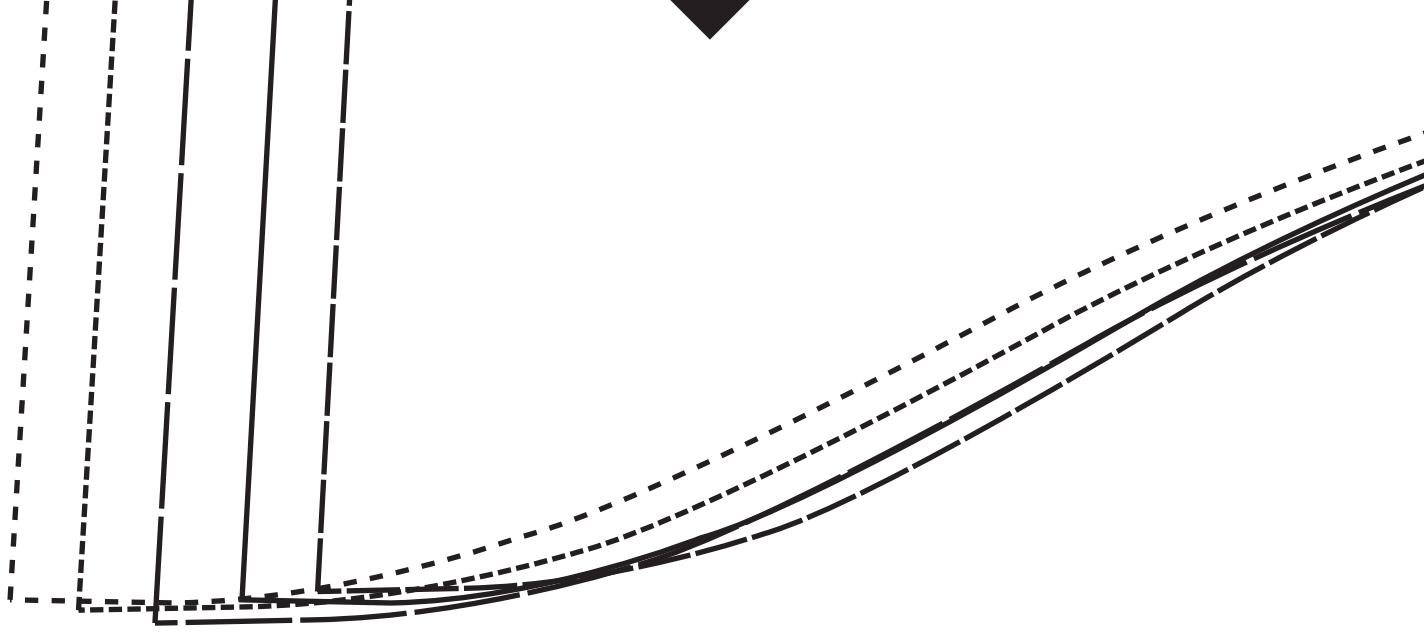



20

REGIB

DONJI

DIO

2x

Id

30

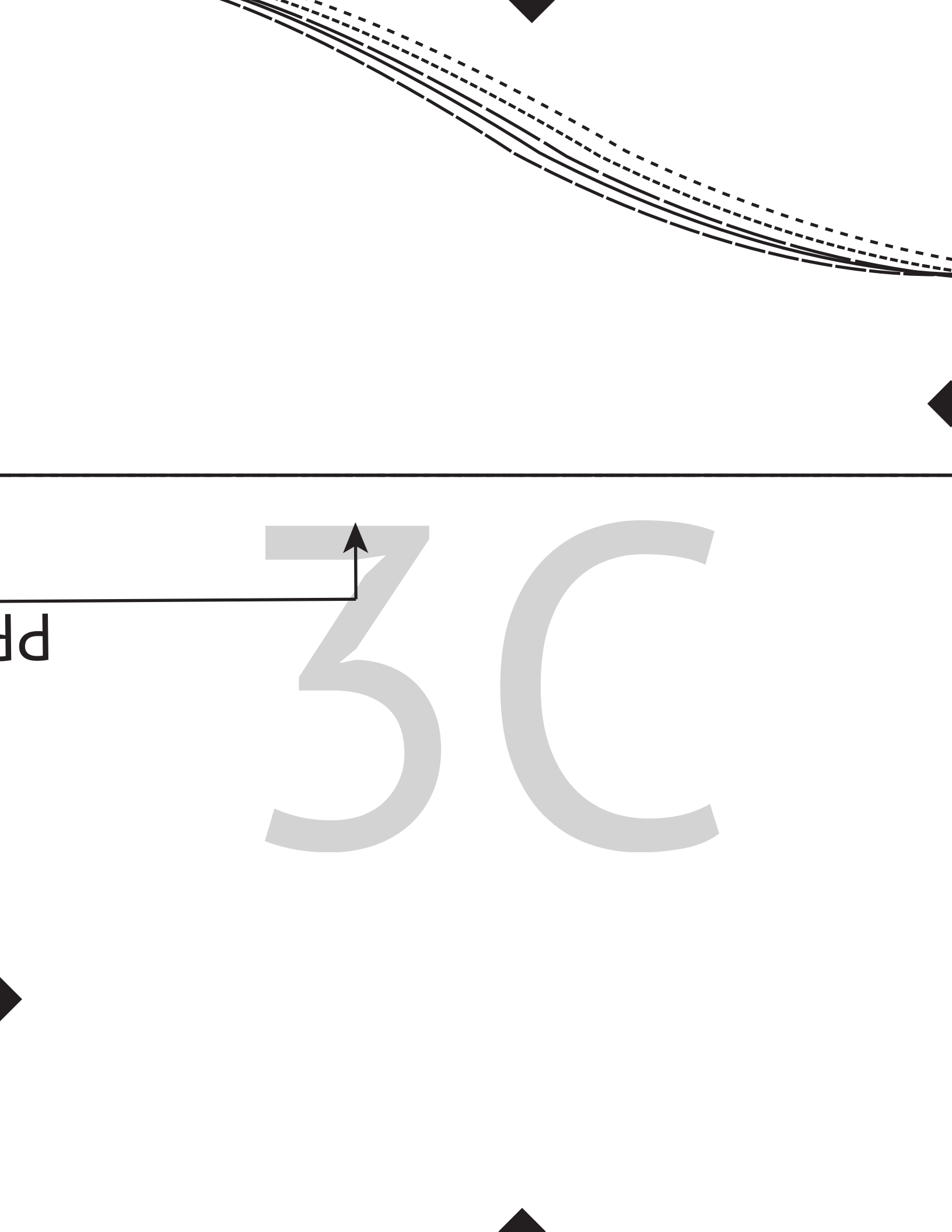

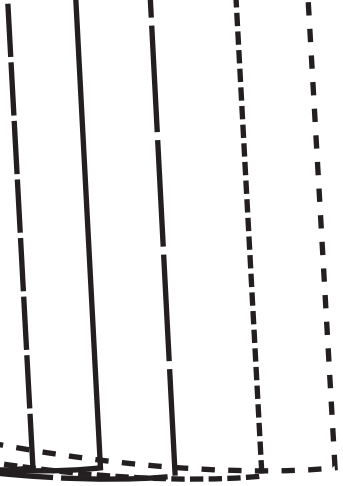

4C

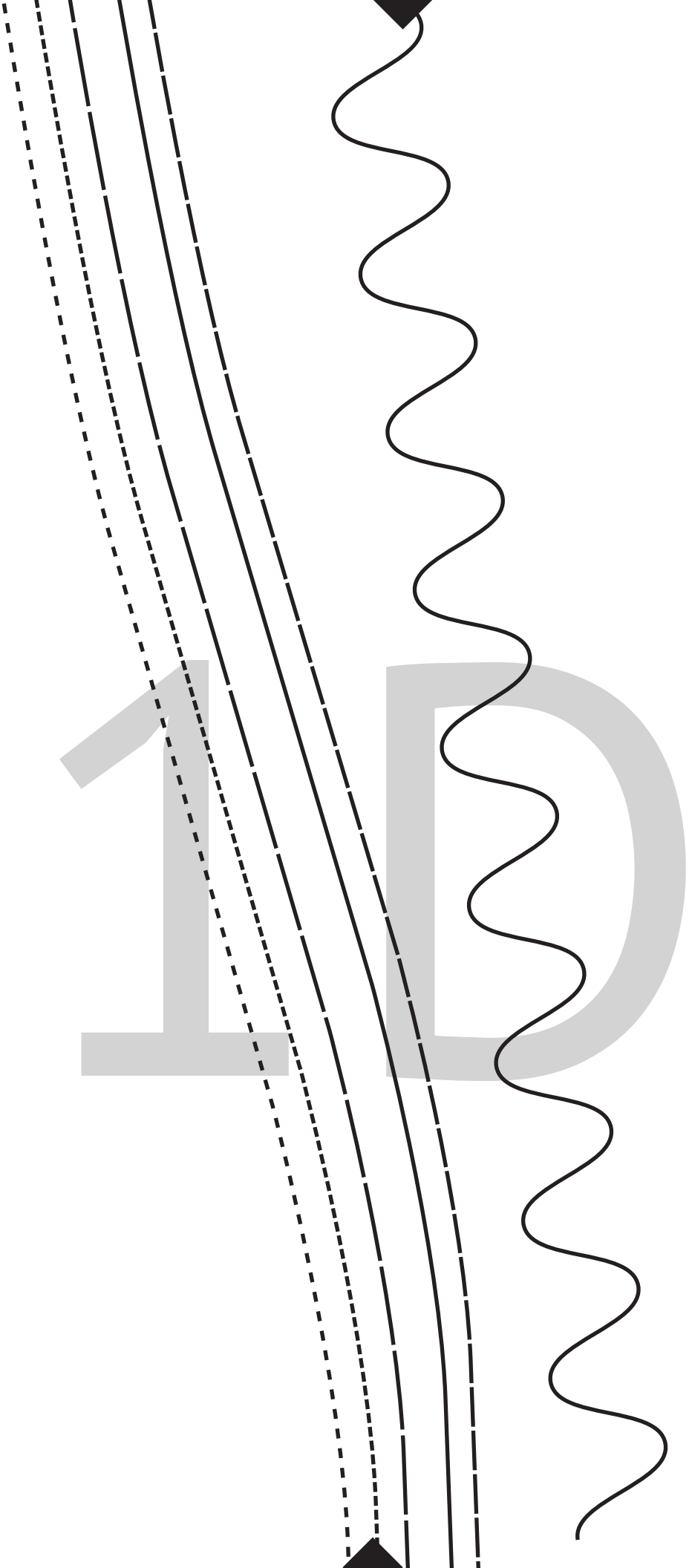

SMJER NITI



2D

3D

4D

1

E

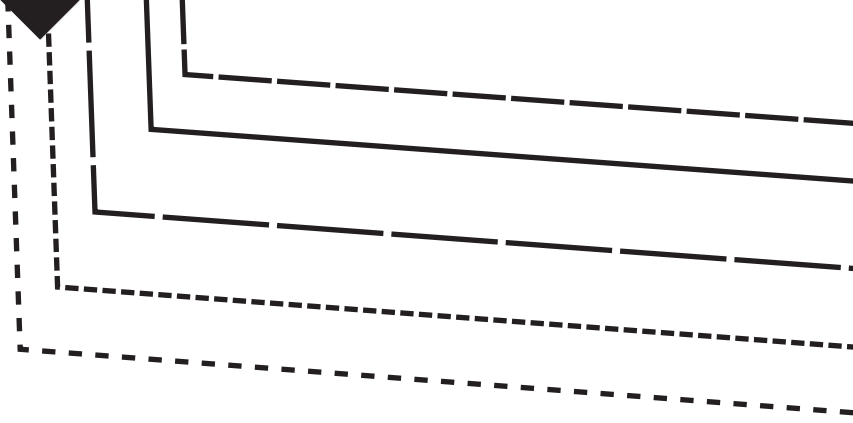
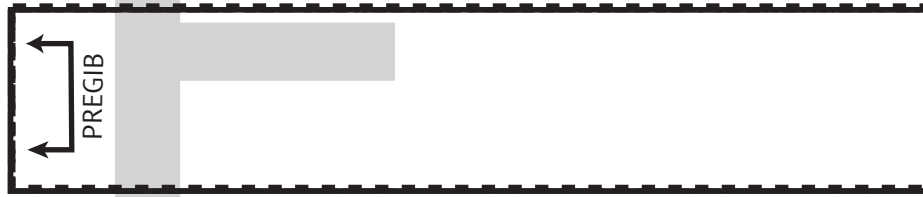

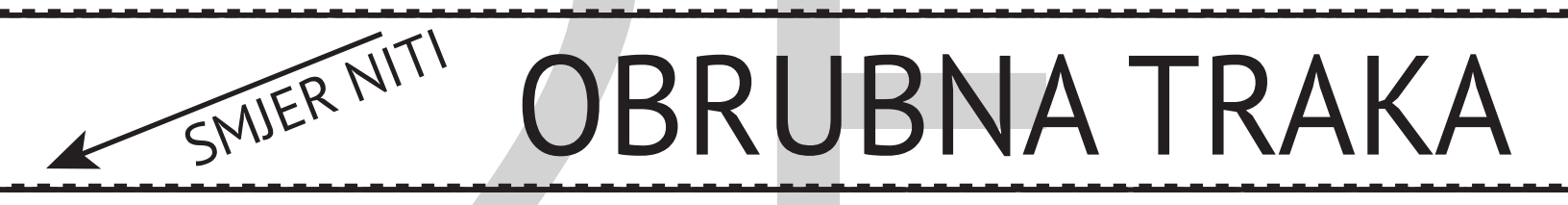
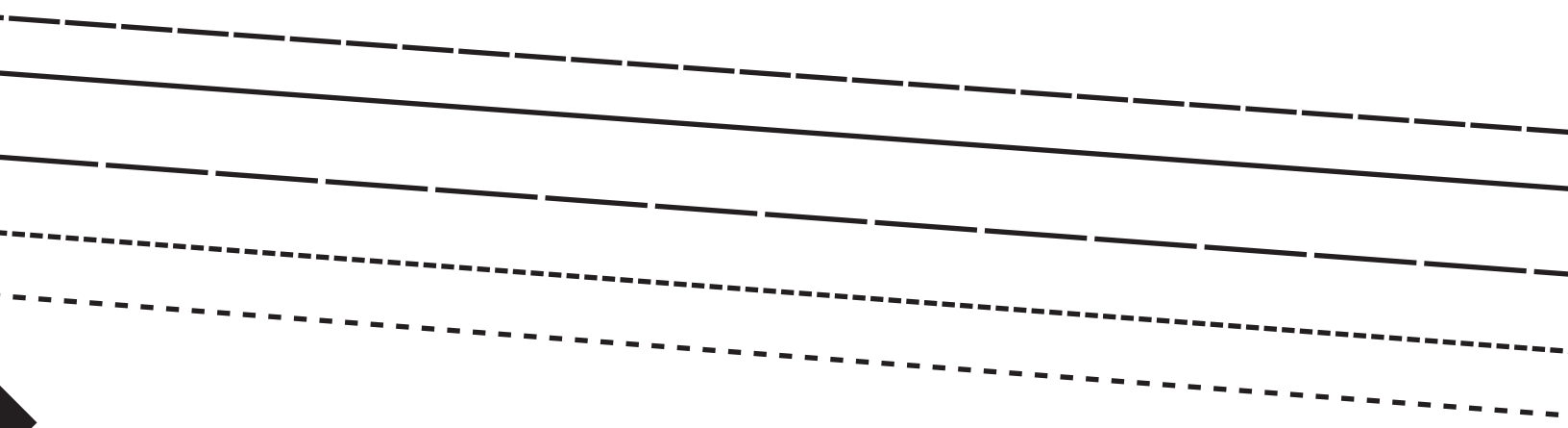

25

SMJER NITI

OBRUBNA TRAKA

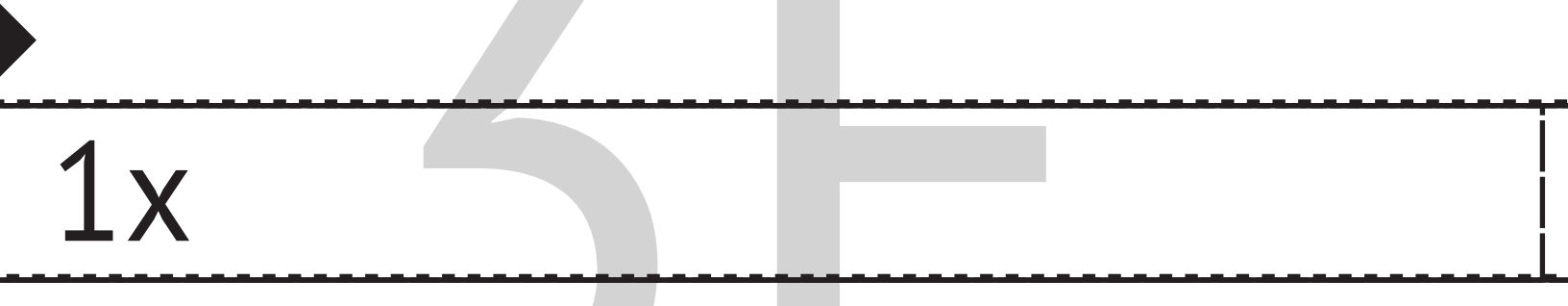

1x

3 E

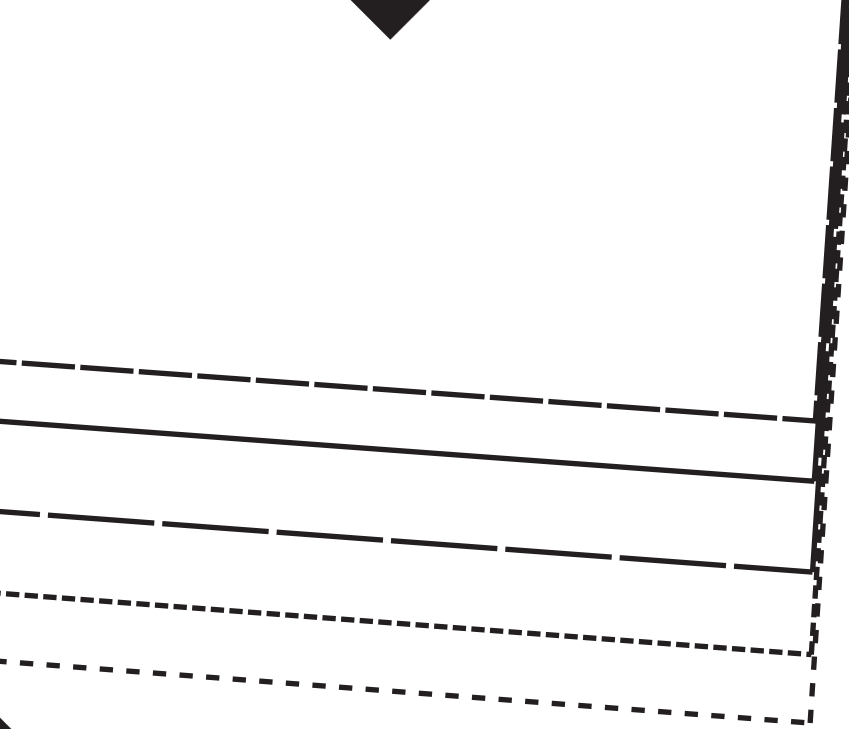

4 E